

Data Sheet



Article number: 12621000120700

Description: Threaded pin 621 000 120.700
For M12

Measures

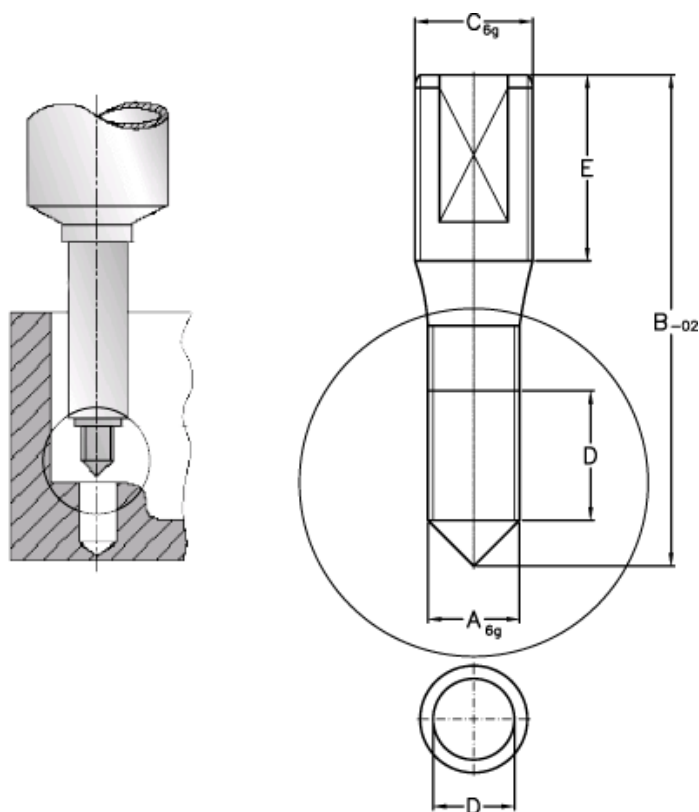

A = M12
B = 120.0
C = M12
D = 24.0
E = 28